

Lieferung
 bereits ab 1 Bundlänge

Vollgummi- und Weich-PVC Rolltorprofile

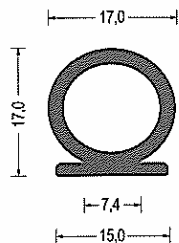

Artikel-Nr. 543.3019
 EPDM · 60° Shore A · schwarz
 VE: Bund á 50m

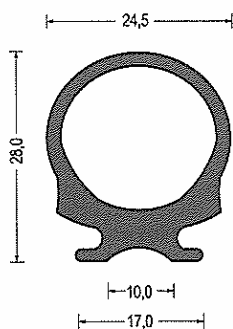

Artikel-Nr. 547.3059
 Weich-PVC · 60° ShoreA · schwarz
 VE: Bund á 40m

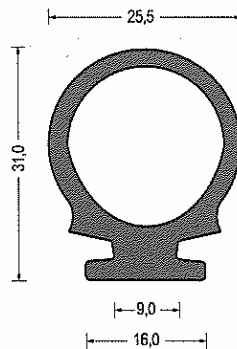

Artikel-Nr. 547.3109
 Weich-PVC · 60° ShoreA · schwarz
 VE: Bund á 40m

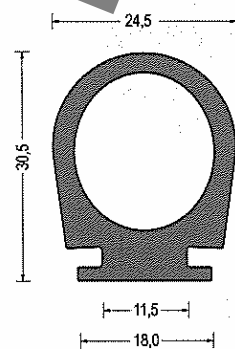

Artikel-Nr. 540.3079
 EPDM · 65° ShoreA · schwarz
 VE: Bund á 50m

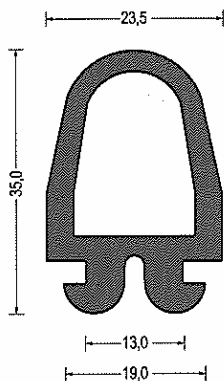

Artikel-Nr. 540.3069
 EPDM · 65° ShoreA · schwarz
 VE: Bund á 25m

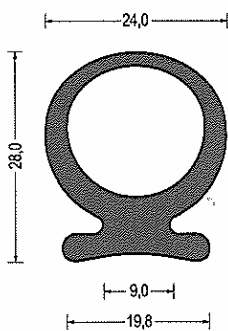

Artikel-Nr. 540.3129
 EPDM · 70° ShoreA · schwarz
 VE: Bund á 25m

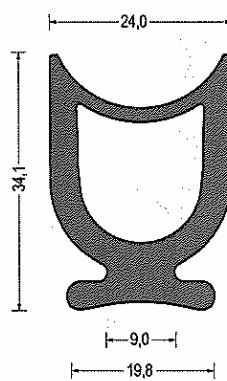

Artikel-Nr. 540.3169
 EPDM · 70° ShoreA · schwarz
 VE: Bund á 25m

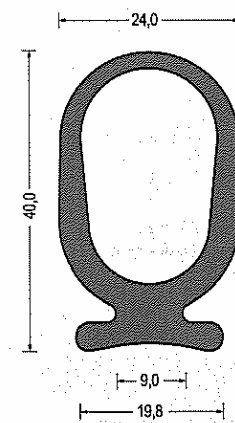

Artikel-Nr. 540.3139
 EPDM · 70° ShoreA · schwarz
 VE: Bund á 25m

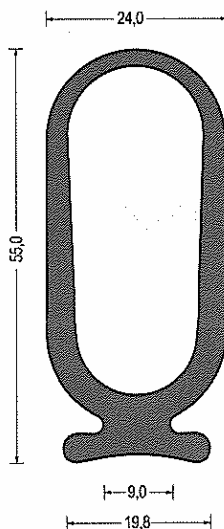

Artikel-Nr. 540.3149
 EPDM · 70° ShoreA · schwarz
 VE: Bund á 15m

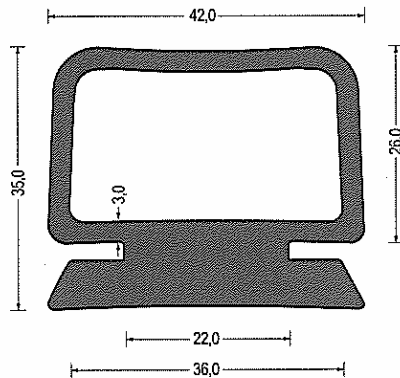

Artikel-Nr. 540.3049
 EPDM · 60° ShoreA · schwarz
 VE: Länge á 8m

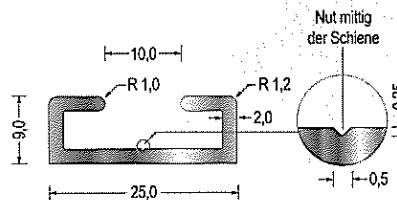

Artikel-Nr. 515.5010
 Halteleiste für Rolltorprofile
 nicht oder nur sehr bedingt geeignet für Profile:
 543.3019 / 540.3079 / 540.3049
 Aluminium blank
 VE: Länge á 5m
 Mindestmenge 10m